

Glass Passivated Bridge Rectifiers

DB101-G Thru. DB107-G

Reverse Voltage: 50 to 1000V

Forward Current: 1.0A

RoHS Device

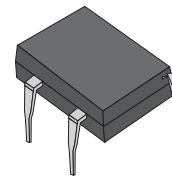

Features

- Rating to 1000V PRV.
- Ideal for printed circuit board.
- Low forward voltage drop.
- High current capability.
- The plastic material has UL flammability classification 94V-0
- UL recognized file # E349301 

Mechanical Data

- Polarity: As marked on Body.
- Weight: 0.38 grams.
- Mounting position: Any.

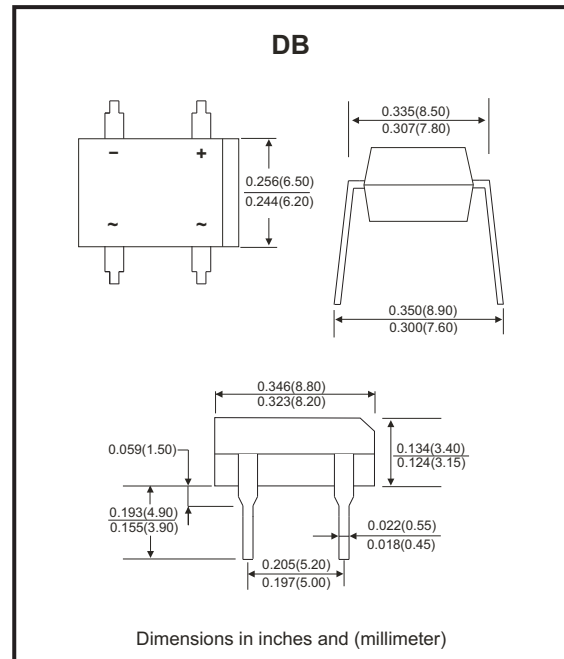

Maximum ratings and electrical characteristics

Rating at 25°C ambient temperature unless otherwise specified.
Single phase, half wave ,60Hz, resistive or inductive load.
For capacitive load, derate current by 20%

Parameter	Symbol	DB 101-G	DB 102-G	DB 103-G	DB 104-G	DB 105-G	DB 106-G	DB 107-G	Unit
Maximum Recurrent Peak Reverse Voltage	V_{RRM}	50	100	200	400	600	800	1000	V
Maximum RMS Voltage	V_{RMS}	35	70	140	280	420	560	700	V
Maximum DC Blocking Voltage	V_{DC}	50	100	200	400	600	800	1000	V
Maximum Average Forward Rectified Current @ $T_A=40^{\circ}C$	$I_{(AV)}$	1.0							A
Peak Forward Surge Current , 8.3ms Single Half Sine-Wave Super Imposed On Rated Load (JEDEC Method)	I_{FSM}	30							A
I^2t Rating For Fusing ($t < 8.3ms$)	I^2t	3.735							A^2s
Maximum Forward Voltage At 1.0A DC	V_F	1.1							V
Maximum DC Reverse Current @ $T_J=25^{\circ}C$ At Rated DC Blocking Voltage @ $T_J=125^{\circ}C$	I_R	10 500							μA
Typical Junction Capacitance (Note 1)	C_J	25							pF
Typical Thermal Resistance (Note 2)	$R_{\theta JA}$	40							$^{\circ}C/W$
Operating Temperature Range	T_J	-55 ~ +150							$^{\circ}C$
Storage Temperature Range	T_{STG}	-55 ~ +150							$^{\circ}C$

Notes:

1. Measured at 1.0MHz and applied reverse voltage of 4.0V DC.
2. Thermal resistance from junction to ambient mounted on P.C.B with 0.5"×0.5" (13×13mm) copper pads.

Company reserves the right to improve product design , functions and reliability without notice.

REV: C

Rating and Characteristics Curves (DB101-G Thru. DB107-G)

Fig.1 - Forward Current Derating Curve

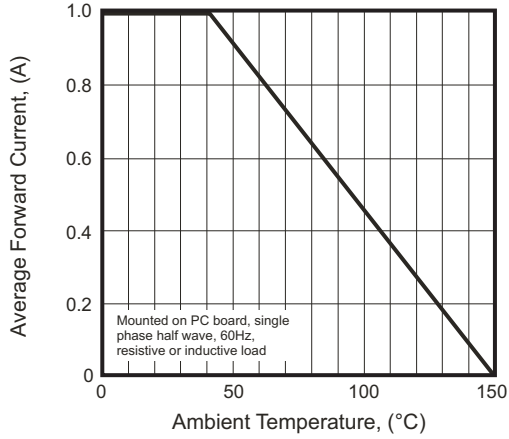

Fig.2 - Typical Forward Characteristics

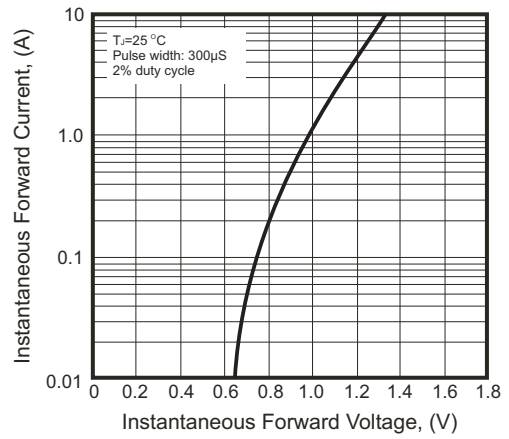

Fig.3 - Maximum Non-repetitive Surge Current

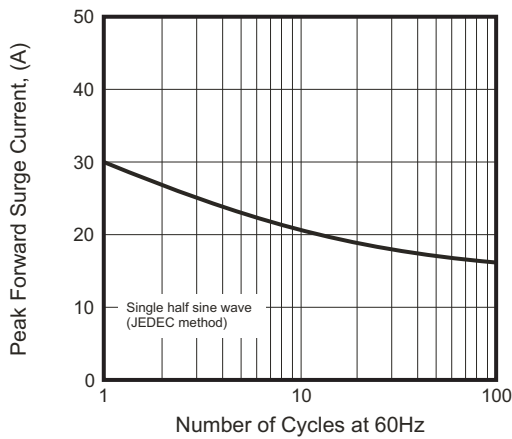

Fig.4 - Typical Junction Capacitance

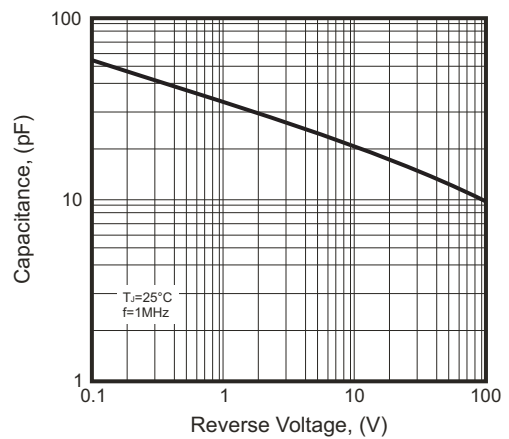
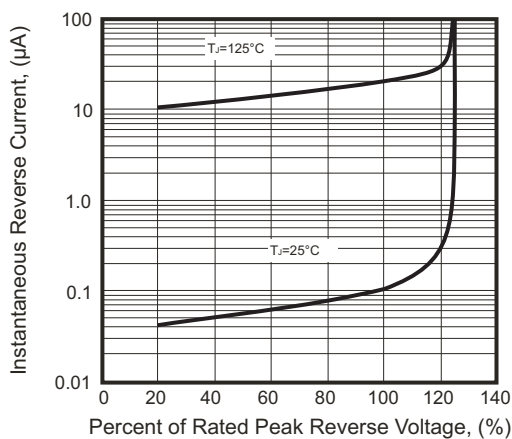

Fig.5 - Typical Reverse Characteristics



Company reserves the right to improve product design, functions and reliability without notice.

REV: C

Marking Code

Part Number	Marking code
DB101-G	DB101
DB102-G	DB102
DB103-G	DB103
DB104-G	DB104
DB105-G	DB105
DB106-G	DB106
DB107-G	DB107

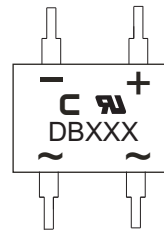

XXX = Product type marking code
 C = Comchip Logo

Standard Packaging

Case Type	TUBE PACK	
	TUBE (pcs)	BOX (pcs)
DB	50	2,500

Mouser Electronics

Authorized Distributor

Click to View Pricing, Inventory, Delivery & Lifecycle Information:

[Comchip Technology:](#)

[DB101-G](#) [DB102-G](#) [DB103-G](#) [DB104-G](#) [DB105-G](#) [DB106-G](#) [DB107-G](#)